

SOLAR PADDY DRYER WITH SOLAR PADDY COOKING SYSTEM

Sangeetha V

Nehru College of Engineering and Research Centre,
Trissur, Kerala, India.
sangeethavinod1997@gmail.com

Sundaramoorthi P

Nehru College of Engineering and Research Centre,
Trissur, Kerala, India.
sundarped.sundar66@gmail.com

Abstract: Paddy is a mandatory food crop in South India. Most of the Paddy farming is in rural areas. After harvesting, the paddy has to move through different stages. One of the important processes of paddy processing is paddy drying. In most of the rural farmers are using open space paddy drying method. It is not an efficient method, where space for open drying is decreasing, and this process is not hygienic one. Insects and dust particles may mix with paddy. Or otherwise, large machinery is using for paddy drying. It may not be accessible for rural or small-scale farmers. Then solar paddy dryer is an alternative method that is useful for rural and small-scale farmers. Solar is renewable energy so; it is safe to process. Free of energy cost. The system is a hybrid one having a paddy dryer with a paddy cooking system. The harvested paddy has a two-stage process before milling for extracting rice, which is cooking partially first and drying. These two processes are satisfied with the system. The system has two chambers, one for cooking the paddy it is by the principle of solar cooker. Solar pressurized cooking is adapting for doing the cooking of paddy. And the suitable solar dryer is selected by software analysis. CFD analysis of solar indirect and mixed dryers is simulating in ANSYS software.

Keywords: CFD analysis, Indirect solar dryer, Mixed solar dryer, Solar cooking system

I. INTRODUCTION

As pollution increases, renewable energy systems usage is more, especially in the case of solar. Solar types of equipment are highly demanding in the market, for example, solar cookers, solar water heaters, solar lights, etc. [1]. In the agricultural field, solar energy is physically essential for plant growth and agriculture product drying. Traditionally drying is by exposing products under the sun, i.e., direct drying [2]. A solar dryer is a device that utilizes solar energy for drying different products such as vegetables, fruits, fish, grains, etc.

Rice is a staple food crop in many countries. After harvesting before milling paddy has to move through two processes that are cooking and drying the paddy [3-4]. The system "Paddy dryer with paddy cooking system" satisfies both the processes before milling. Now paddy cooking is done by using fuels, and open drying is doing. But space is decreasing for this way of drying. Farmers having small areas are difficult to do this. And fuel for cooking is not renewable [5]. So, this system is very much useful for paddy farmers for safe and efficient paddy processing.

It is a two-chamber system first chamber for cooking and another for drying. Solar forced dryer and mixed solar dryer principles are experimenting here [6]. In the paddy cooking system principle of solar cooker is applying for a desirable result. In a single system, two processes are satisfied. The agricultural sector is a primary sector a basic need, technologies appalling in the agriculture field will be helpful for farmers and to improve the agricultural industry [7]. The system is a useful product for paddy farmers on a small scale, if the capacity increases it can use for large-scale paddy production [8].

For suitable solar dryer selection, CFD analysis is applying. Solar mixed dryer and indirect dryer are testing then a suitable dryer is selecting for hardware development. ANSYS simulation software is using for CFD analysis [9]. In solar cooking chambers are also CFD analysis is applying [11]. The cooking chamber needs an almost higher temperature over the dryer so pressurizing of the cooker is doing for achieving the need [10] [12].

II. Methodology

A. FD Analysis

Figure 1 shows the CFD analysis of solar mixed dryer in ANSYS R2 2020.

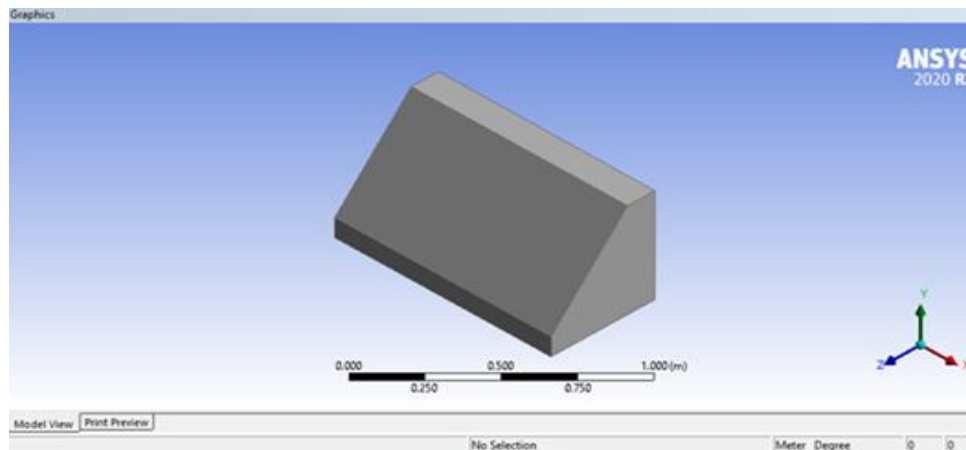

Fig. 1 Geometry of mixed solar dryer

B. Values Assigning

- Gravity - -9.81 about Y axis
- Solar calculator
- Energy calculator
- Longitude degree - 73
- Latitude degree - 10.9
- Time zone - 5:30
- Properties of boundary materials: glass, wood, collector
- Air and water vaper properties according to dew point

Figure 2 shows the flow of temperature inside mixed solar dryer chamber. Temperature is high at the left end and varying to another end. It shows that, temperature is almost high inside the chamber. Figure 3 shows the pressure flow.

Pressure is high at the bottom side and it varies and low at the upper position. Figure 4 shows the turbulence. In fluid dynamics turbulence is fluid motion characteristics by change in pressure and flow velocity. Turbulence flow is medium range top and bottom and low at intermediate. Figure 5, radiation from solar to the chamber. Since it is mixed dryer, radiation will be higher at the exposed area and near the collector and medium range at the top of the chamber. Figure 6 shows mass flow. Mass flow is the movement of fluids down and pressure or temperature gradient. Figure 7 shows the flow of velocity streamlines. Inside the dryer flow of hot vaporised air are there, the velocity stream lines of that air.

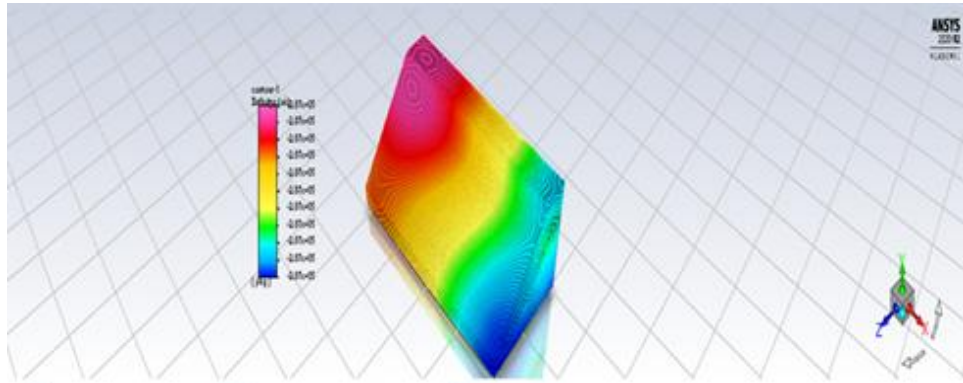

Fig. 2 Temperature CFD result

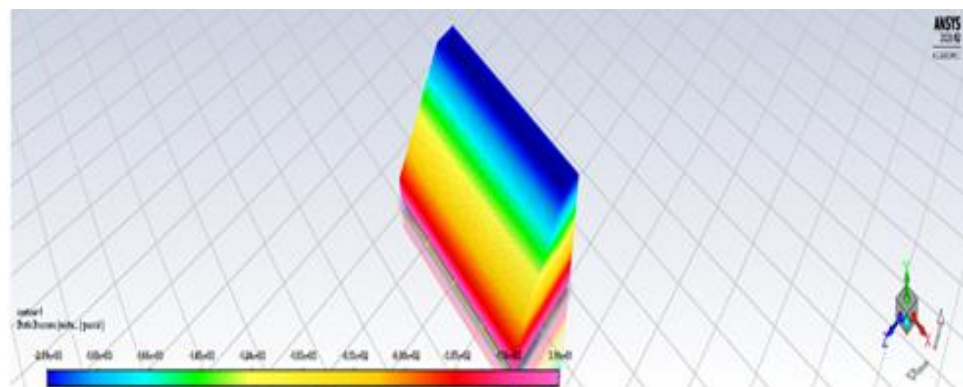

Fig. 3 Pressure CFD result

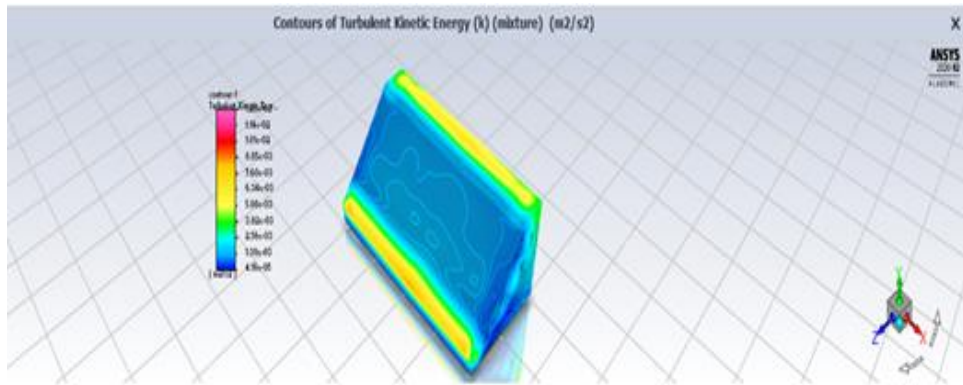

Fig. 4 Turbulence CFD result

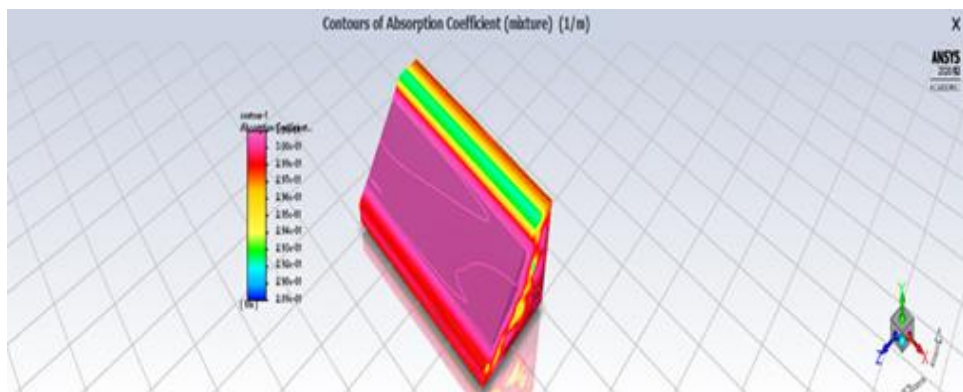

Fig. 5 Radiation CFD result

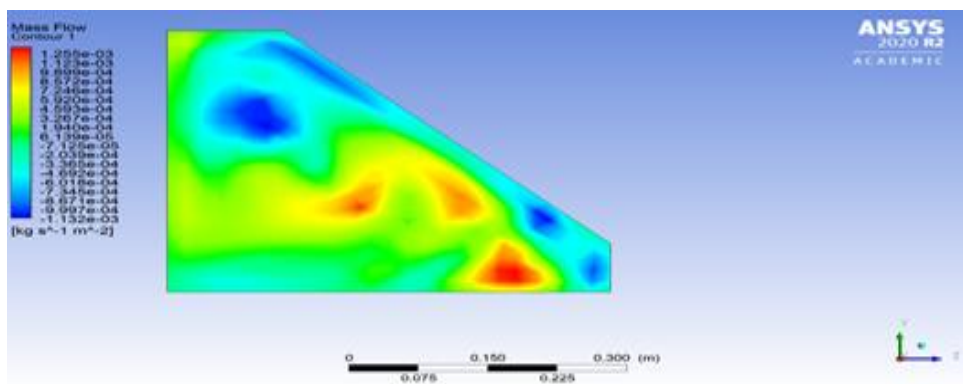

Fig. 6 Mass flow CFD result

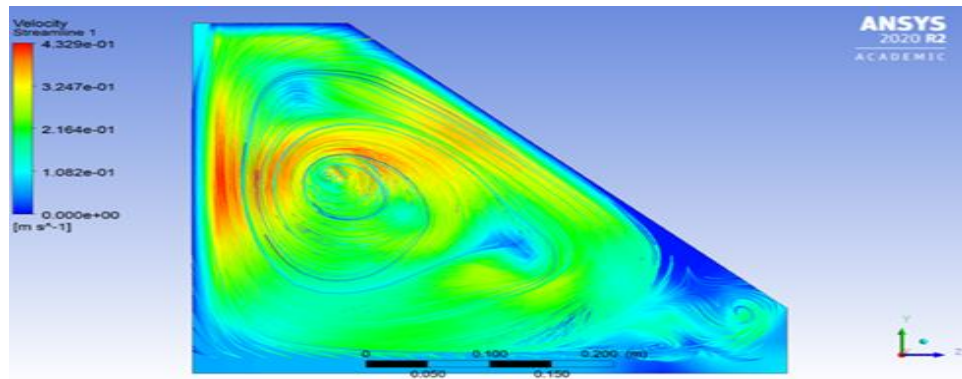

Fig. 7 Velocity Stream lines CFD result

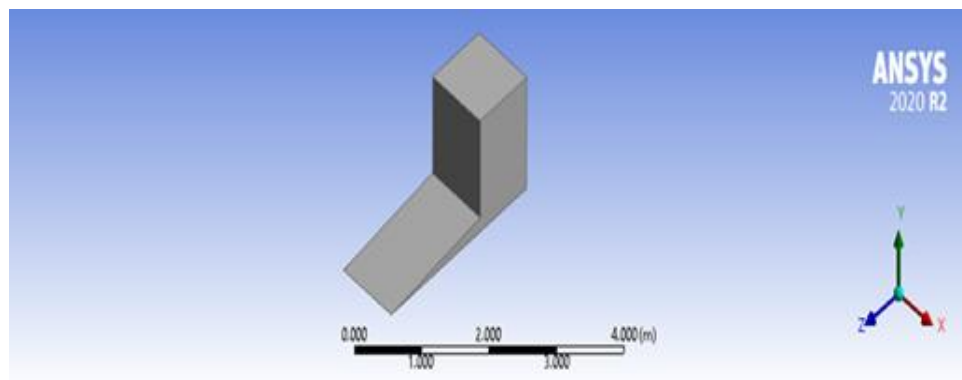

Fig. 8 Geometry of indirect dryer

C. Values Assigned

- Gravity - -9.81 about Y axis
- Solar calculator
- Energy calculator
- Longitude degree - 73
- Latitude degree - 10.9
- Time zone - 5:30
- Properties of boundary materials wood, collector
- Air and water vapor properties according to dew point

D. Result

Figure 9 shows the temperature flow in indirect dryer chamber. A varying temperature at collector and constant temperature inside the chamber. Figure 10 shows the pressure. Pressure is high and almost same in the system. Figure 11, turbulence. Turbulence is low and constant all-over the system. Figure 12 velocity stream lines are low when compared to mixed solar dryer.

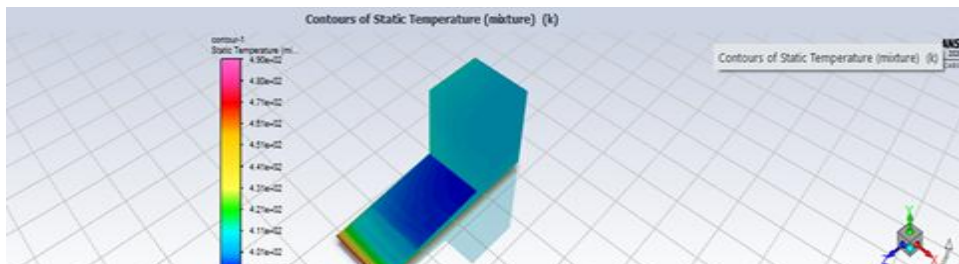

Fig. 9 Temperature CFD result

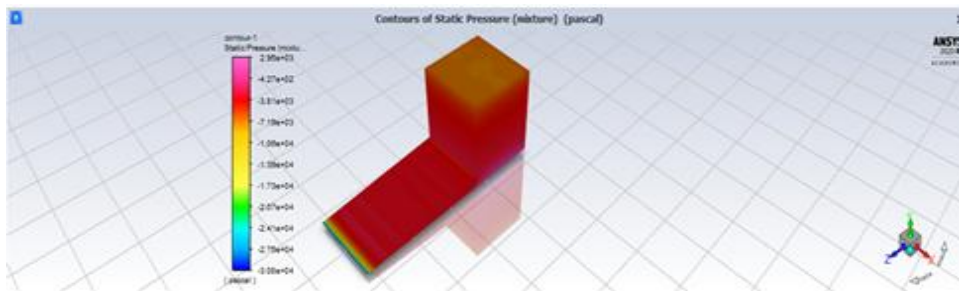

Fig. 10 Pressure CFD result

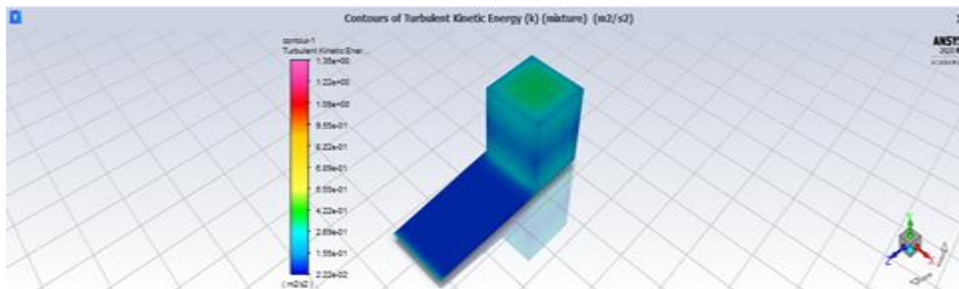

Fig. 11 Turbulence CFD result

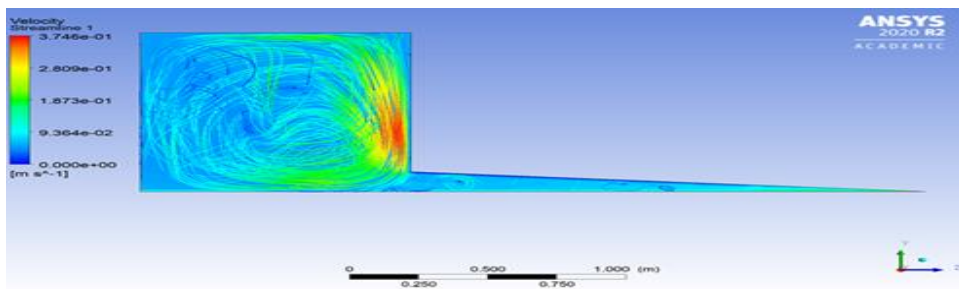

Fig. 12 Velocity streamlines

E. Conclusion of Simulation

By comparison, solar mixed dryer and indirect solar dryer solar mixed dryer is better as per CFD analysis Demerit of solar mixed dryer is direct solar light may harm the product but in the case of paddy it has hard shell so mixed dryer is suitable for paddy drying. In next phase solar paddy cooker CFD analysis and hardware of the system will develop.

F. Block Diagram

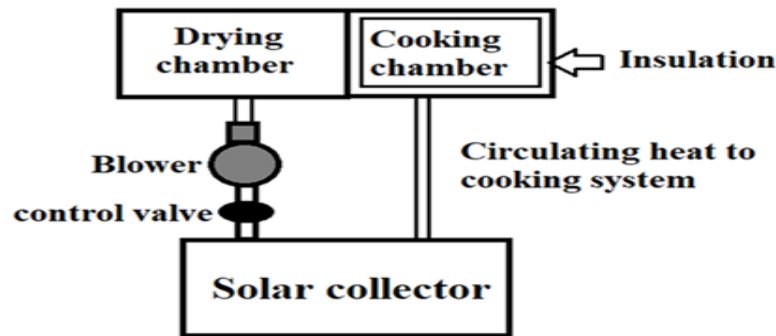

Figure 13: Block diagram

G. Block Diagram Description

It is a two-chambered system, solar paddy drying chamber, and solar cooking chamber as depicted in Figure 13. The solar collector is connected to both chambers. Solar collector temperature range of 40-to-80-degree C. 5 kg of paddy capacity system is developing. Solar dryer chamber sizing 0.216-meter cube volume and Solar cooking system chamber sizing approximately 0.027-meter cube. Solar drying chamber needs large volume because drying is doing by spreading the product inside the chamber in trays. The blower is using for the forced circulation of hot air to the solar dryer chamber. The control valve is providing for the controlling process. As in the case of solar cooking it can adapt suitable circulation as per evaluation. The cooking chamber should be suitably insulated to maintain the heat inside. The first process of the system is cooking. After cooking paddy shell will partially open then known that the paddy is cooked. Paddy needs to dry below 14%. Moisture content of paddy is measured by weight measurement

H. Diagram of Cooking System

In the solar cooker, the cooking chamber should well-insulated higher temperature is needed compared to the dryer. This design of the solar cooker is of natural circulation oil is using as heat-conducting fluid

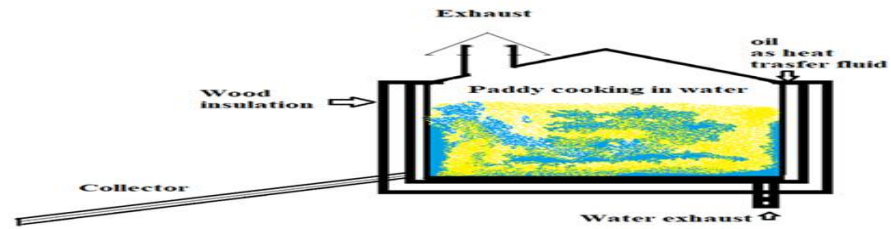

Fig. 14 Diagram of cooking system

I. Diagram of Solar Dryer System

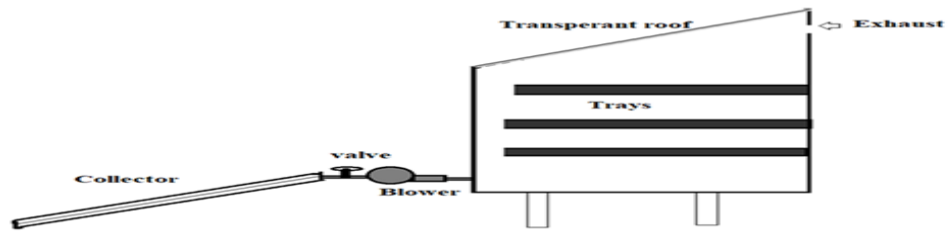

Fig. 15 Diagram of solar dryer system

Evacuated tube collector is there for absorbing solar heating energy and it is controlled and given to blower which will force circulated the hot air. It is given to the bottom side of the chamber. Inside the chamber, drying trays are arranged for drying the paddy. A transparent cover is there so it is a mixed dryer and a ventilation opening is provided.

J. Hardware Development

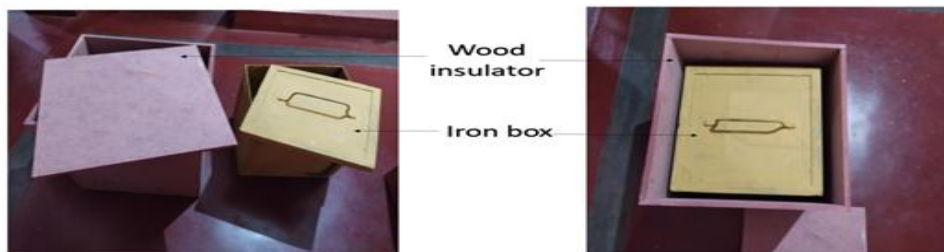

Fig. 16 Cooking chamber insulations

The wooden chamber is the outer insulation. Wood is given to trap heat inside the cooking system. Iron box is there for filling connecting fluid. Boxes should be close with tight leads for better heat trapping of heat. Iron box is 30*30*30 volume.



Fig. 17 Cooking chamber

Figure 17 shows Inner most chamber is the cooking chamber which is of aluminium. 5 kg of paddy is filling in this chamber. Volume of chamber is 0.125-meter cube.

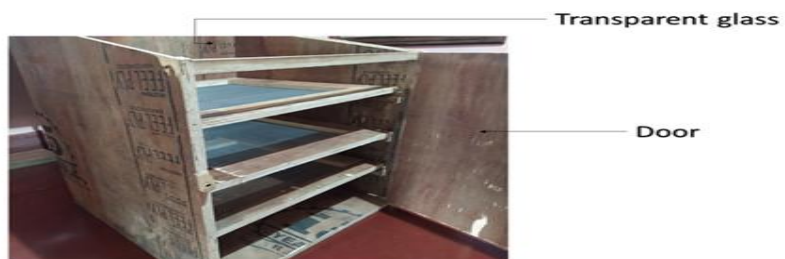

Fig. 18 Dryer Chamber



Fig. 19 Dryer trays

Figure 19 shows the dryer chamber, there is door and a transparent glass layer on the top for entering solar energy through it. There are three number of trays inside the chamber for spreading paddy on the tray. Trays are of net type so better heat circulation will be there Each tray are of 60*60 area.



Fig. 20 Evacuated tube collector

Figure 20 shows the most important part of the system solar collector. Evacuated tube collector is using for converting solar energy to heat energy in the system. Evacuated tube collector has more advantages over flat plate collector.

Advantages of Evacuated tube collector

- Large surface area exposed to the sun then more ability to capture sunlight.
- More efficient in heat transfer
- Excellent performance in over cast conditions
- Requires small roof area
- Less corrosion

a. Blower

Blower is using for Transferring heat from the collector to the dryer chamber. It helps to increase the normal pressure.

b. Heating Coil

Heating coil is using for connecting collector with cooking system. Coil is connector to connecting fluid.

K. Cooking System

Cooking system have three chambers inner most one is of aluminium, where paddy and water mixture is putting for cooking. Middle layer is of iron material where the conducting fluid and the heating coil from the solar collector is connecting to this layer. The outer most layer is wood box, it is an insulation layer which trap heat inside the system itself. The cooker is pressurised by tight led for improving cooking efficiency with lesser time.

5kg rice and water of 3 to 4 litres mixture is taking in the aluminium chamber. Oil is the heat transfer fluid, connect the heating coil from the evacuated solar collector to the fluid. After cooking we can see that the paddy shell is partially open then cooking is complete.

L. Oil Circulation

Oil circulation is more efficient than water circulation. Paddy needs almost 80 to 100 degrees of heat. A heat transfer fluid should have high thermal conductivity and fluid should have high boiling point. Oil has high boiling point than water and good conductivity so, oil is selected. Natural circulation of oil is provided.

M. Dryer System

The cooked paddy has to dry using mixed solar dryer. The paddy should spread over the trays arranged in the dryer chamber. A blower should connect to the chamber from solar collector. A controlling valve should be there for regulation of pressure. Paddy should dry up to 14% of the moister of paddy. It is calculating by weight measurement.

III. RESULT

TABLE. 1 Readings of solar dryer

Days	Time	Solar intensity W/sq. m	Inlet temperature (°C)	Dryer temperature (°C)
Day 1	10.50 am	317	34.1	42.5
	11.50 am	534	36.4	49.7
	12.50 pm	645	44.8	52.3
	1.50 pm	850	46.2	55.6
	2.50 pm	710	43.5	53.4
	3.50 pm	547	39.3	46.2
Day 2	10.50 am	398	36.2	42.5
	11.50 am	477	38.5	44.1
	12.50 pm	568	42.6	49.6
	1.50 pm	819	45.8	50.3
	2.50 pm	657	39.6	48.4
	3.50 pm	418	31.4	43.7

TABLE. 2 Reading of open sun drying (Traditional method)

Days	Time	Solar intensity W/sq. m	Ambient temperature(°C)
Day 1	10.50 am	347	37.3
	11.50 am	476	38.5
	12.50 pm	578	41.3
	1.50 pm	743	45.7
	2.50 pm	618	40.4
	3.50 pm	542	38.6
Day 2	10.50 am	324	33.1
	11.50 am	518	39.8
	12.50 pm	629	42.5
	1.50 pm	746	44.6
	2.50 pm	573	40.8
	3.50 pm	447	34.7
Day 3	10.50 am	317	36.4
	11.50 am	573	44.8
	12.50 pm	645	46.9
	1.50 pm	854	43.5
	2.50 pm	710	39.3
	3.50 pm	547	38.5

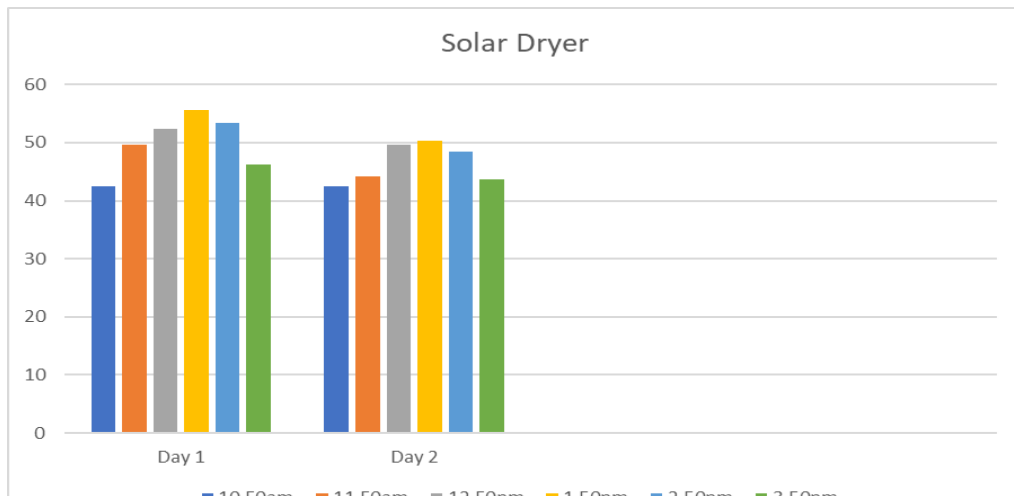

Fig. 21 Solar dryer chart

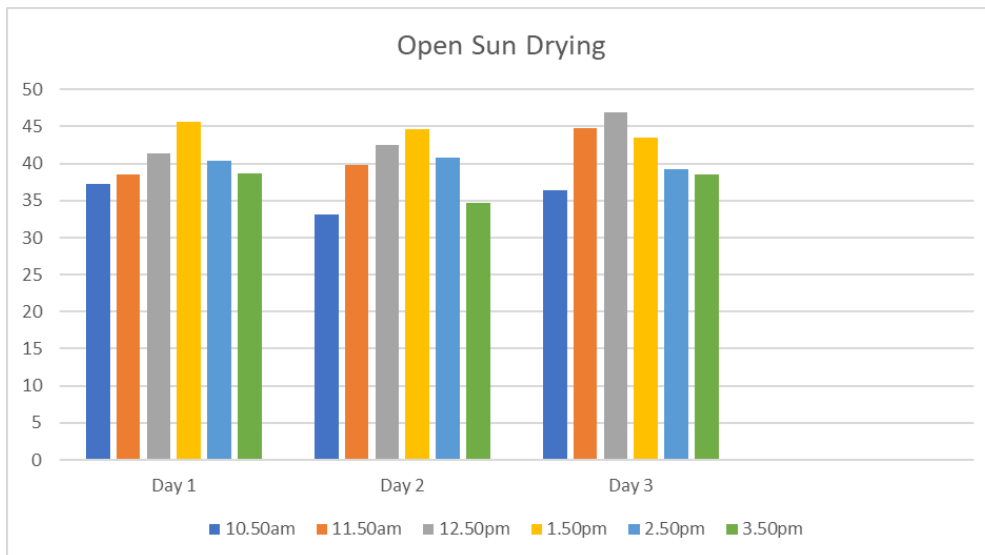

Fig. 22 Open sun drying chart

A. Solar Dryer Result

The solar dryer needs only a lower temperature range when compared to the cooking system. In a solar dryer, the collector temperature that is inlet temperature is well pressurized and gives to the dryer chamber and direct solar rays also fall on the chamber through a transparent wall. Two days are needed for the rice to fully dry as per requirement. The weight of the paddy will reduce from 5kg to 4.4kg.

TABLE. 3 Reading of solar cooker

	Time	Solar Intensity W/Sq. m	Inlet temperature (°C)	Pressure Cooker temperature (°C)
Day 1	10.50am	350	34.1	87.6
	11.50am	546	36.4	90.1
	12.50pm	690	44.8	99.5
	1.50pm	886	46.3	100.1
Day 1	2.50pm	725	43.5	97.7
	3.50pm	564	39.3	93.3

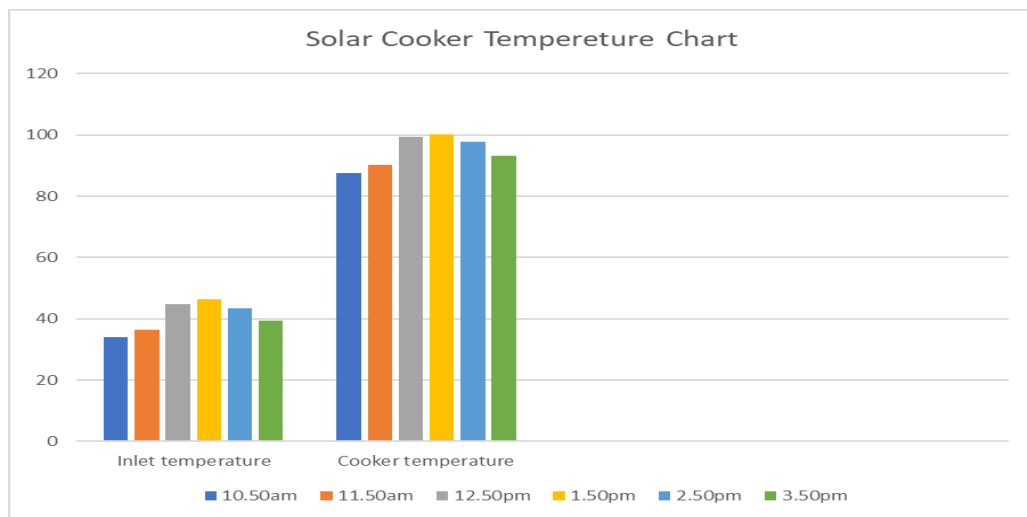

Fig. 23 Solar cooker temperature chart

B. Solar Cooker Results

Solar-based cooking of paddy needs a higher temperature. Higher temperature is achieved at the chamber by maintaining pressure. When compared to inlet temperature the cooker has a higher temperature. One day peak time is using for cooking paddy shell have practical opened and then cooking have completed.

IV. CONCLUSION

In the system, a solar paddy dryer with a paddy cooking system has been designed. By this design, two processes of paddy processing will satisfy. It is useful for small-scale paddy farmers and paddy industries. Traditional methods have many disadvantages these are coping up with renewable technologies. Solar cooker of suitable circulation can do. In a solar cooker which is the elements are selected for a different layer of chambers Solar dryer mainly has three

classifications, direct, indirect, and mixed dryers. Solar indirect and mixed dryers are evaluating by CFD simulation.

By comparison, solar mixed dryer and indirect solar dryer. A solar mixed dryer is better as per CFD analysis. Temperature, pressure, turbulence, and velocity streamlines are evaluated. A demerit of the solar mixed dryer is direct solar light may harm the product but in the case of paddy, it has a hard shell so a mixed dryer is suitable for paddy drying. Solar dryer and cooker in a same system can satisfy and renewable technology applying in agricultural sector is process done by this system.

REFERENCES

- [1] Performance Evaluation of Various types of Solar Dryer and Drying Technologies, Harshit P. Bhavsar Research Scholar, Department of Mechanical Engineering, School of Engineering, R.K.University, Gujarat, IJAST 2020
- [2] CFD Analysis of Greenhouse Solar Dryer with Different Roof Shapes, Purusothaman M, School of Mechanical Engineering, Sathyabama Institute of Science and Technology, Chennai-119, India, IEEE2020
- [3] Hybrid PV-T Solar Collector using Amorphous Type of Solar Cells for Solar Dryer, Elieser Tarigan Dept. of Electrical Engineering, and PusLET University of Surabaya, IEEE 2020.
- [4] Development of a Solar Paddy Dryer with Hybrid Heating System, Conrado F. Ostia Jr et. al. School of Electrical, Electronics and Computer Engineering, Mapua University, IEEE 2019
- [5] Effects of Chilli Dryer by using Heat Energy from Solar, Den Kogphimai et. al., Faculty of engineering and architecture, Rajamangala university, Thailand, IEEE 2019
- [6] Computational fluid dynamics analysis of greenhouse solar dryer, M. Purusothaman International Journal of Ambient Energy 2019
- [7] Analysis of Flow Through Solar Dryer Duct Using CFD, Prof. A.I. Ambesange et al, IJEDR 2017
- [8] A Review on Passive Solar Dryers for Agricultural Products, A. Balasuadhakar et. al., IJIRST –International Journal for Innovative Research in Science & Technology, Volume 3, Issue 01, June 2016
- [9] CFD analysis of flow and geometric parameter for a double walled solar cooking unit, R Velraj, Research gate, 2014
- [10] A Review of Direct and Indirect Solar Cookers, Mohammadreza Sedighi, Mostafa Zakariapour, Sustainable Energy, 2014
- [11] SDSim: A Novel Simulator for Solar Drying Processes, Yolanda Bolea, Antoni Grau and Alexandre Miranda Automatic Control Department, Technical University of Catalonia UPC Barcelona, Spain, IEEE 2012.
- [12] Performance Evaluation of a Mixed-Mode Solar Dryer, Bukola O. Bolaji and Ayoola P. Olalusi, Research gate 2008